

QUASAR

H O L L A N D

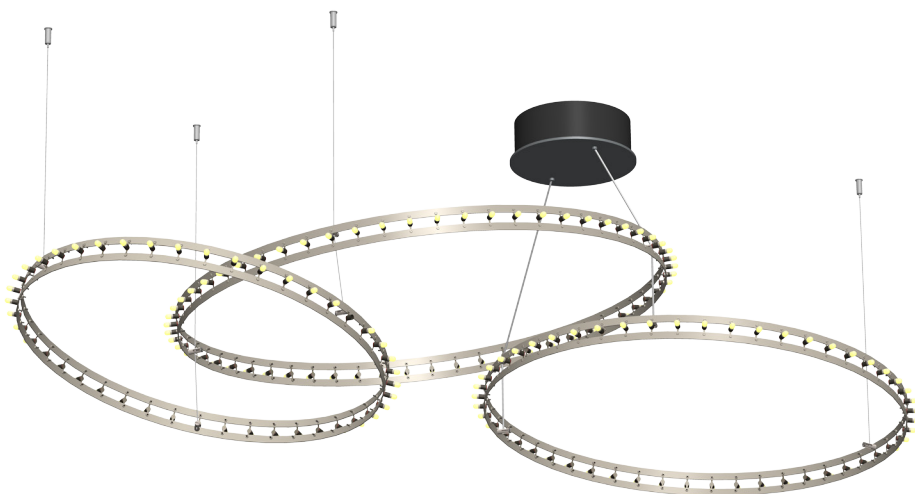

Citadel Composition

NL Installatie handleiding

DE Installationsanleitung

EN Installation manual

1 NL Informatie / DE Information/ EN Information

Veiligheidsinformatie



- Onderbreek altijd de stroomtoevoer door verwijderen van de toestelzijdige stop bij de montage, onderhoudswerk en het verwisselen van de gloeilampen.
- Een brandende lamp is heet. Let op brandgevaar.
- De lamp mag niet op geleidend materiaal worden gemonteerd.
- Draag geen sieraden bij onderhoudswerkzaamheden.
- Geen (decoratie) materialen aan het armatuur bevestigen.

Technische informatie



- Ingangsspanning 120V of 240V
- Uitgangsspanning 12V
- Beschermingsklasse I
- Beschermingsgraad IP20
- De lamp mag niet in openlucht gebruikt worden
- LED Krypton: 12V, 2W
LED: 12V, 0.3W, 2700K, CRI 80
- Ten minste een afstand van 0,5m tenopzichte van het bestraalde oppervlakte houden.
- Technische gelijkvormigheid volgens EN-Richtlijnen

Onderhoudsinformatie



- De lampen reinigen met in de handel verkrijgbare, niet-agressieve en niet-schurende reinigingsmiddelen
- Gebruik een plumeau

Sicherheitshinweise

- Bei Montage, Wartungsarbeiten und Leuchtmittelwechsel immer Stromzufuhr durch Entfernen der bauseitigen Sicherung unterbrechen.

Wenn die Leuchte in Betrieb ist, besteht beim Glühmittel Verbrennungsgefahr!

- Leuchte darf nicht auf leitende Materialien montiert werden.
- Keine Juwelen während Wartung tragen.
- Keine (dekoration) Materialien an die Leuchte befestigen.

Technische Hinweise

- Eingangsspannung 120V oder 240V
- Ausgangsspannung 12V
- Schutzklasse I
- Schutzart IP20
- Leuchte darf nicht im Freien verwendet werden.
- Krypton: 12V, 2W
LED: 12V, 0.3W, 2700K, CRI 80
- Mindestabstand zur angestrahlten Fläche 0,5m
- Technische Konformität gemäss EU-Richtlinien

Pflegehinweise

- Leuchten nur mit handelsüblichen, nicht aggressiven und scheuernden Reinigungsmitteln reinigen.
- Gebrauch eine Federbesen

Safety information

- During installation, maintenance work and change of illuminants always interrupt the power supply by removing the respective circuit breaker.

- When switched on, the lamp may cause burns when touched.

- Lamp may not be mounted on conductive materials.
- Don't wear jewelry during maintenance.
- Don't use decoration materials in the lamp.

Technical data

- Input voltage 120V or 240V
- Output voltage 12V
- Safety class I
- Degree of protection IP20
- Lamp must not be used in the open.
- Krypton: 12V, 2W
LED 12V, 0.3W, 2700K, CRI 80
- Minimum distance from illuminated surface 0.5m
- Technical conformity according to European EN-Regulations

Maintenance information

- Lights should only be cleaned using commercially available, non-aggressive, non-scouring cleaning agents.
- Use a feather duster

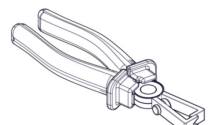
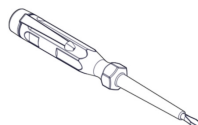
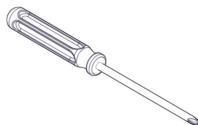
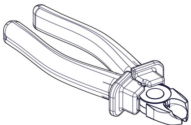
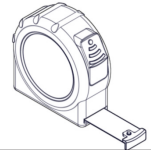
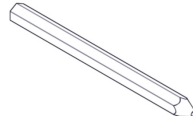
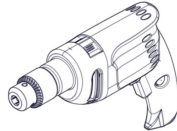
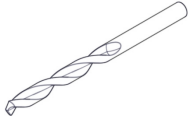

2.1 NL Informatie / DE Information/ EN Information

line 120 or 240 volt

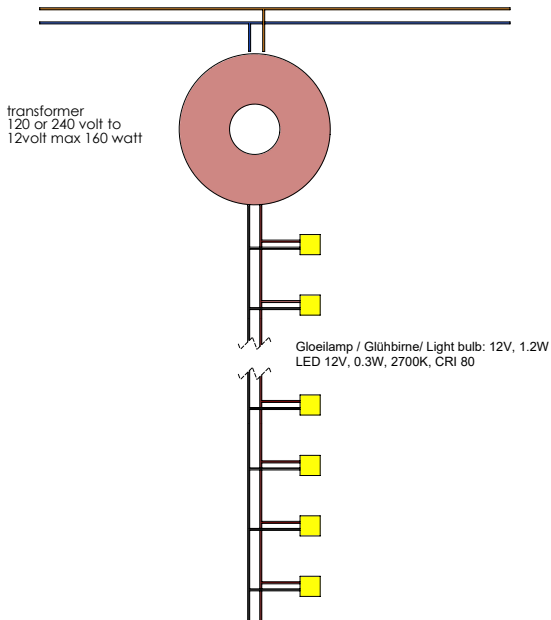

2.2

Citadel Compsoition D.78 44 bulbs

Gloeilamp / Glühbirne / Light bulb total = 52.8 Watt

LED total = 13.2 Watt

Citadel Compsoition D.100 60 bulbs

Gloeilamp / Glühbirne / Light bulb total = 72 Watt

LED total = 18 Watt

Citadel Compsoition D.140 88 bulbs

Gloeilamp / Glühbirne / Light bulb total = 105.6 Watt

LED total = 26.4 Watt

Citadel Compsoition D.180 113 bulbs

Gloeilamp / Glühbirne / Light bulb total = 135.6 Watt

LED total = 33.9 Watt

Citadel Compsoition D..... bulbs

Gloeilamp / Glühbirne / Light bulb total = Watt

LED total = Watt

Citadel Compsoition D.89 52 bulbs

Gloeilamp / Glühbirne / Light bulb total = 62.4Watt

LED total = 15.6 Watt

Citadel Compsoition D.120 75 bulbs

Gloeilamp / Glühbirne / Light bulb total = 90 Watt

LED total = 22.5 Watt

Citadel Compsoition D.160 100 bulbs

Gloeilamp / Glühbirne / Light bulb total = 120 Watt

LED total = 30 Watt

Citadel Compsoition D.200 126 bulbs

Gloeilamp / Glühbirne / Light bulb total = 151.2 Watt

LED total = 37.8 Watt

3.1 NL Installatie / EN Installation / DE Installation

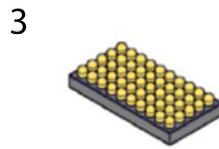
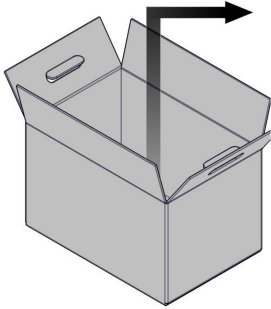

3.2

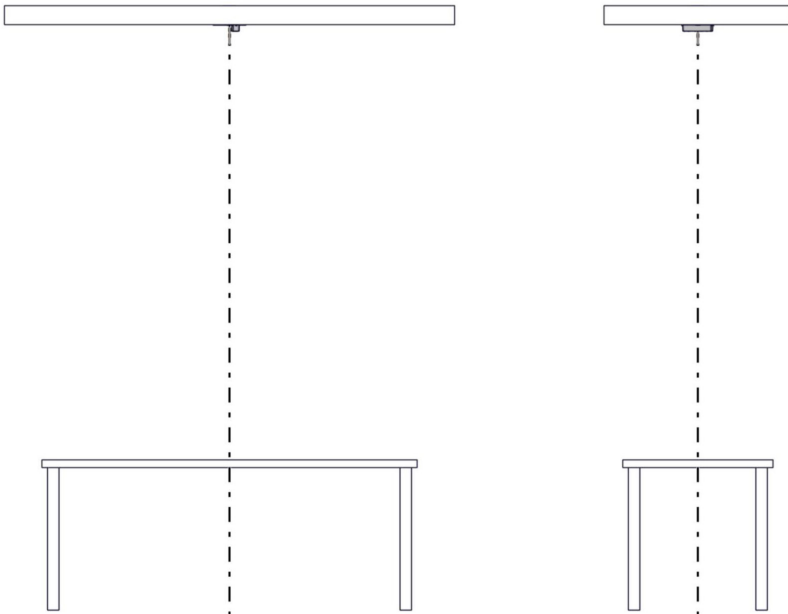

3.3 NL Installatie / EN Installation / DE Installation

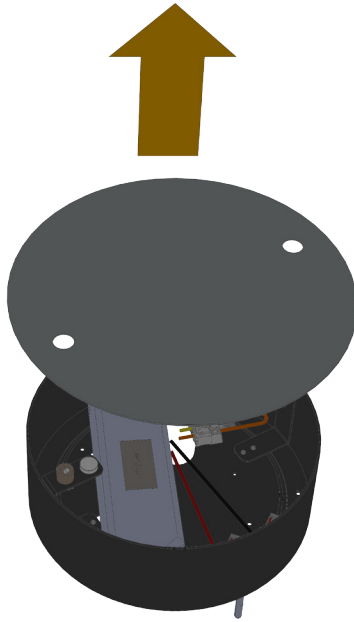

3.4

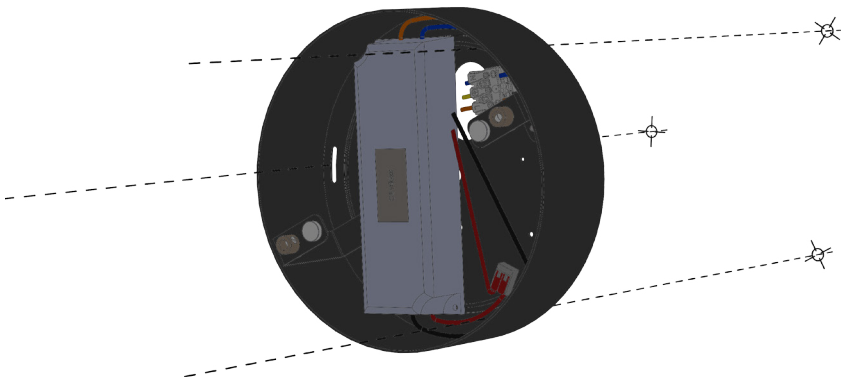
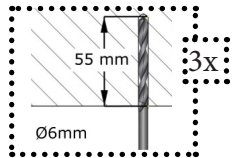
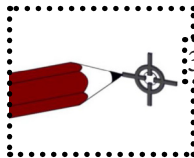

3.5 NL Installatie / EN Installation / DE Installation

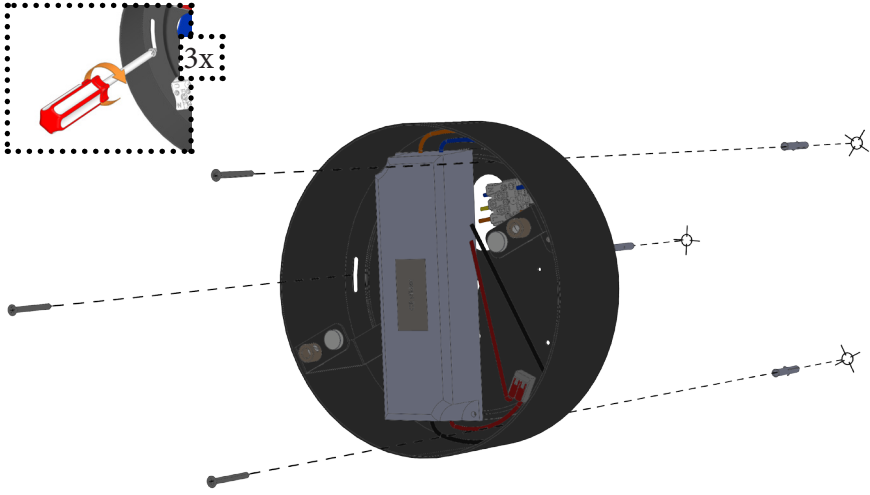

3.6

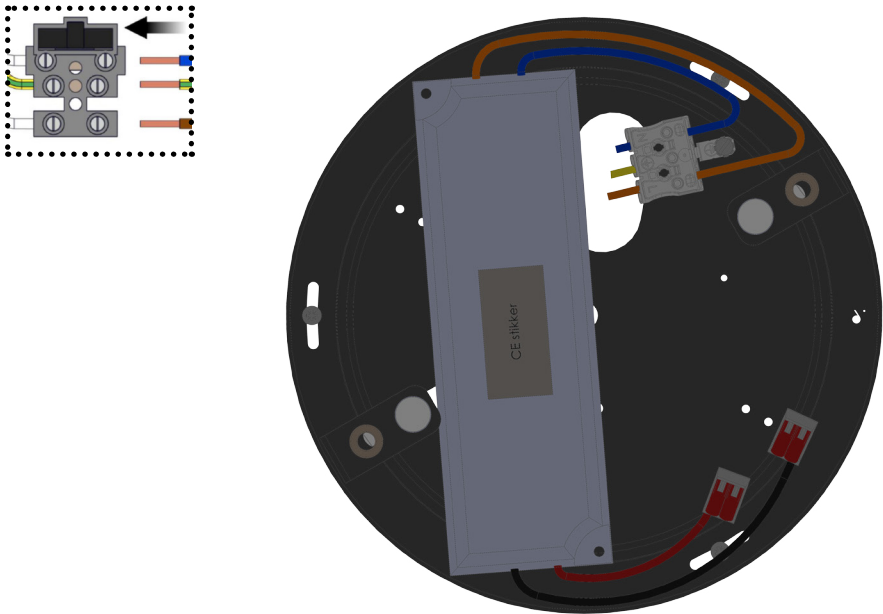

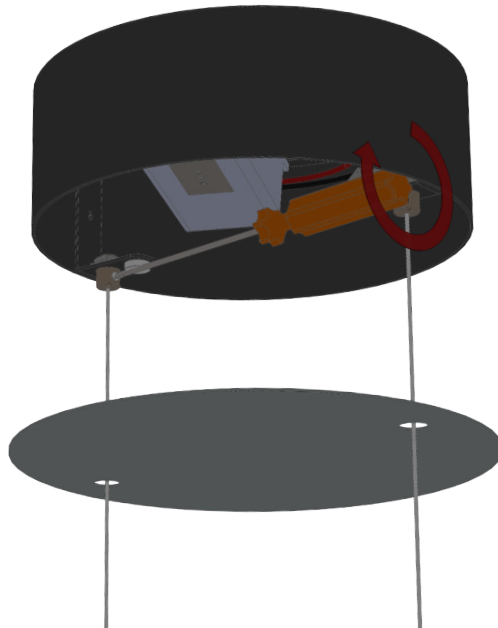
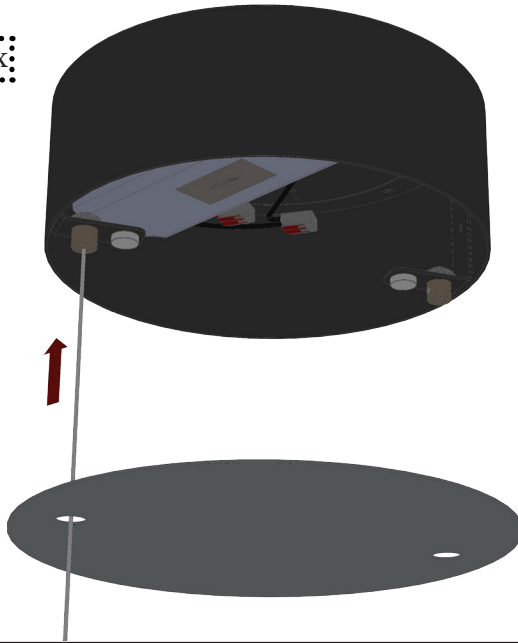
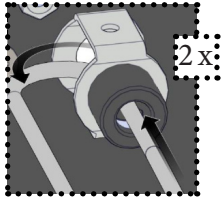

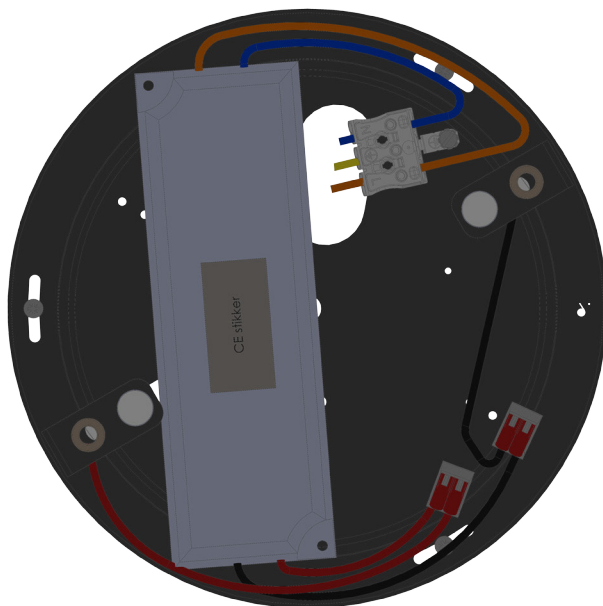
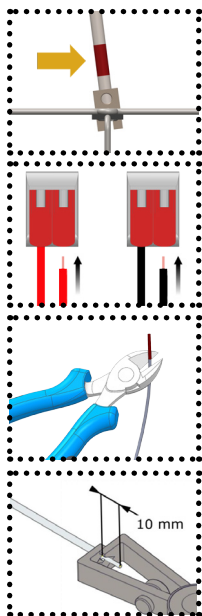

3.10

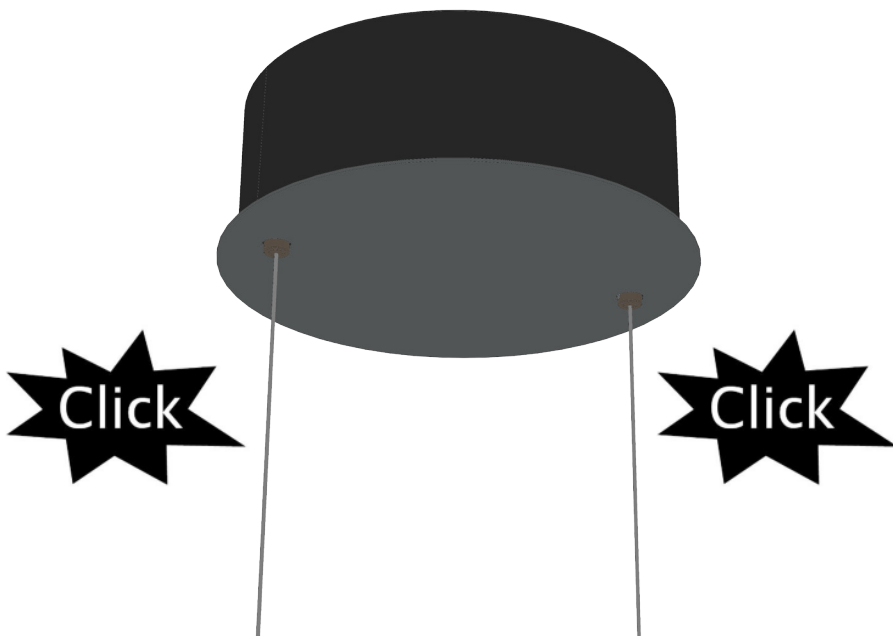

3.11 NL Installatie / EN Installation / DE Installation

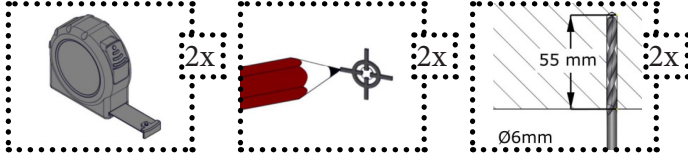

3.12

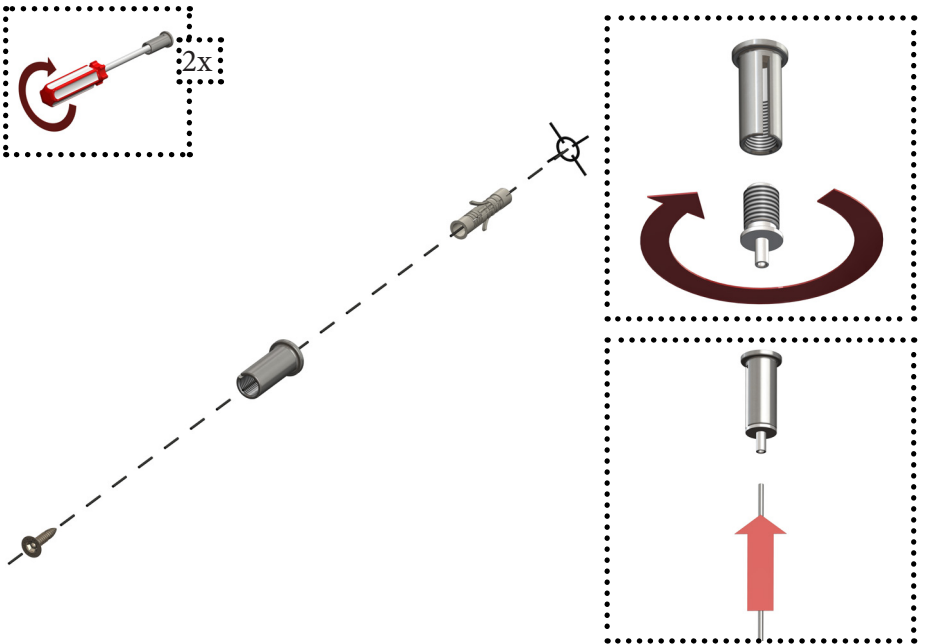

3.13 NL Installatie / EN Installation / DE Installation

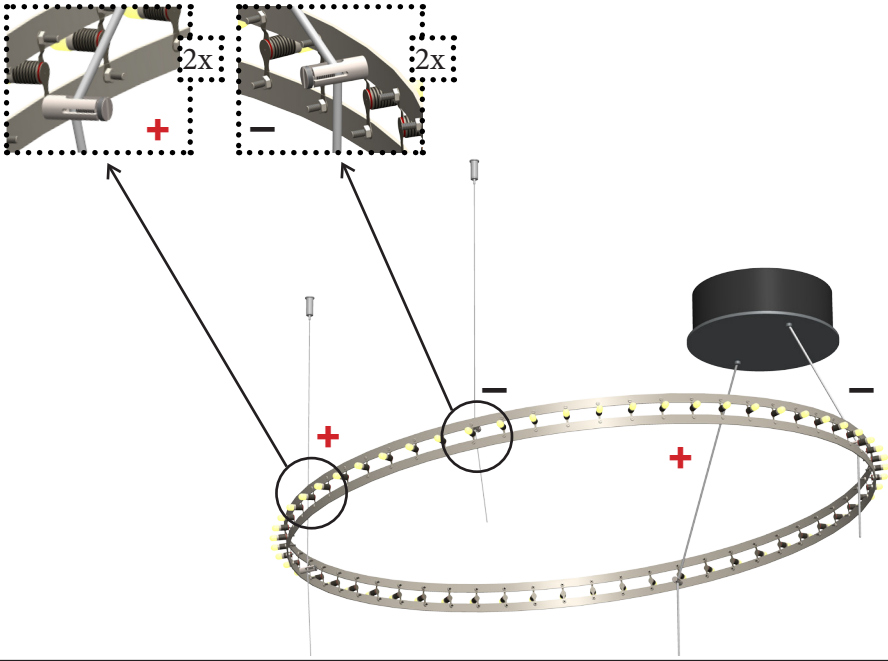

3.14

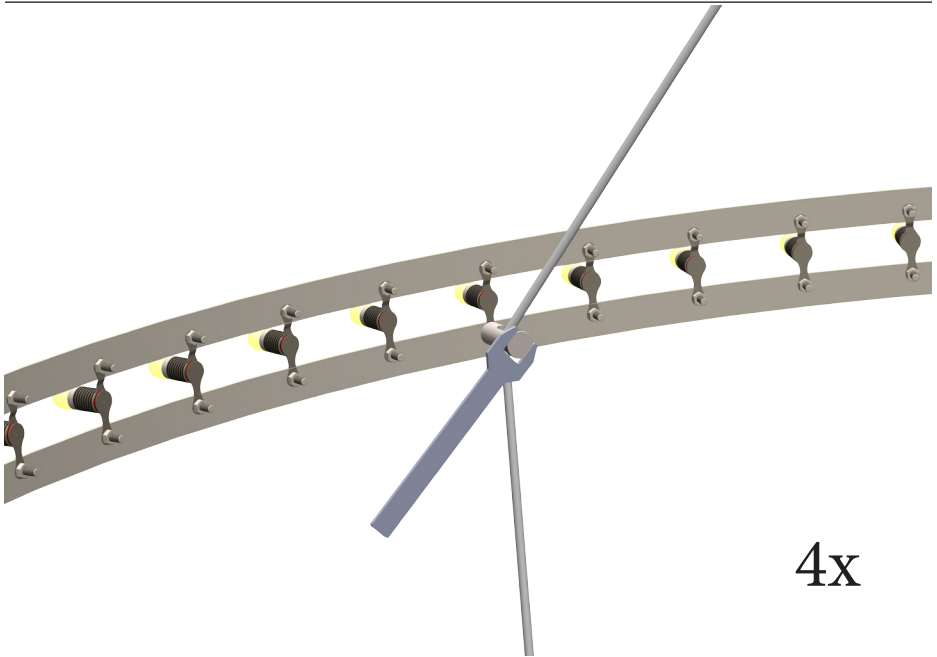

3.15 NL Installatie / EN Installation / DE Installation

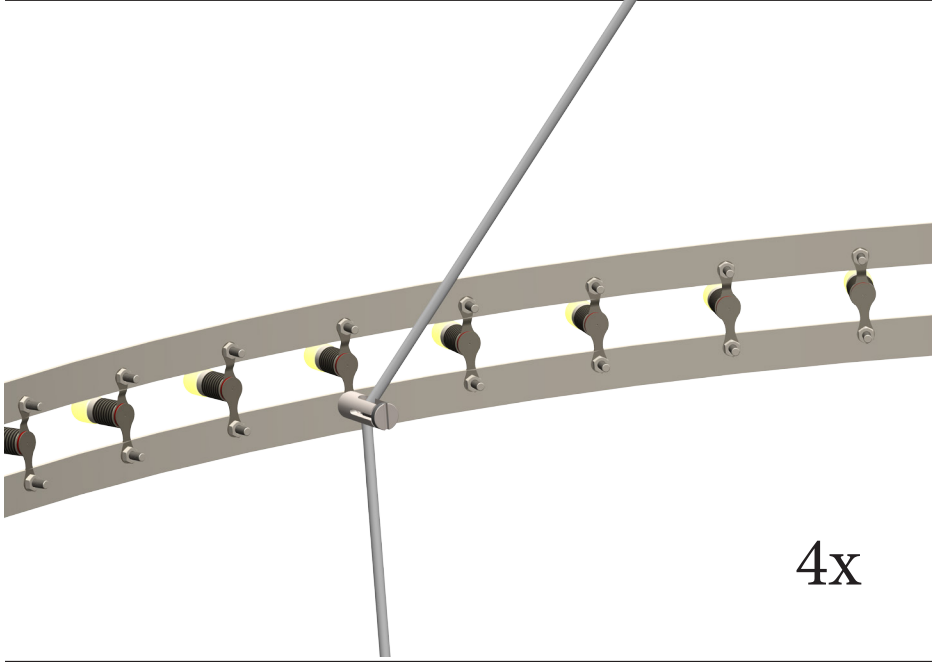

3.16

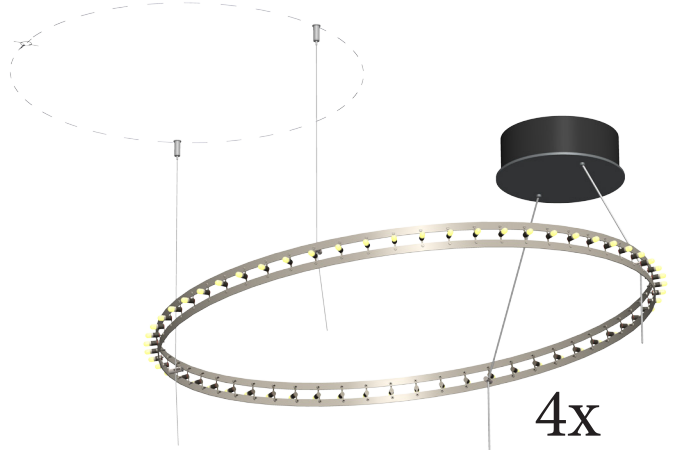
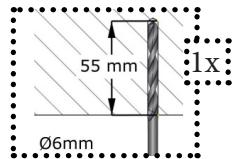
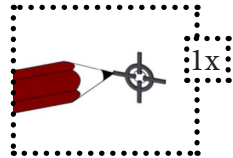
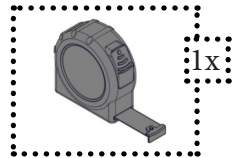

Ø depending on
chosen Citadel ring



Repeat step 3.10 -> 3.15

3.18

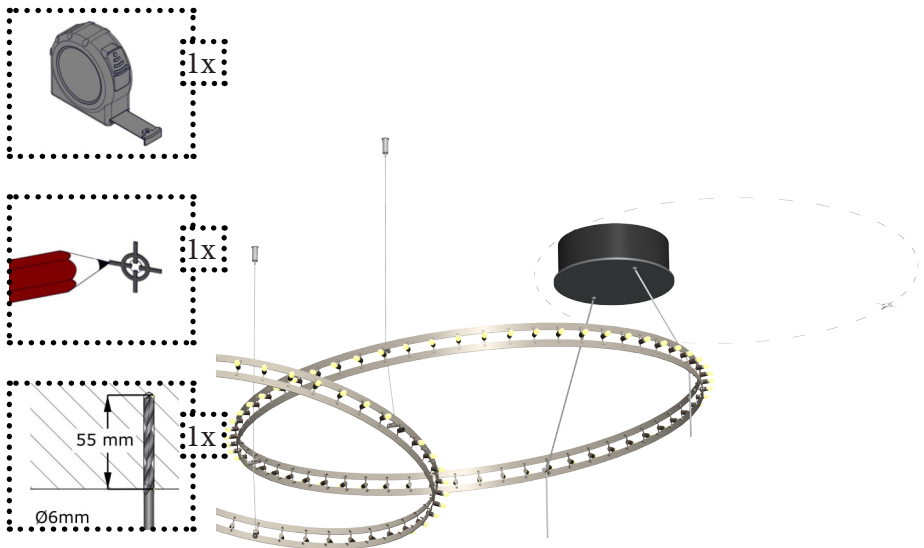

Ø depending on
chosen Citadel ring



Repeat step 3.10 -> 3.15

3.20

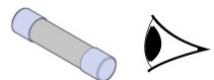
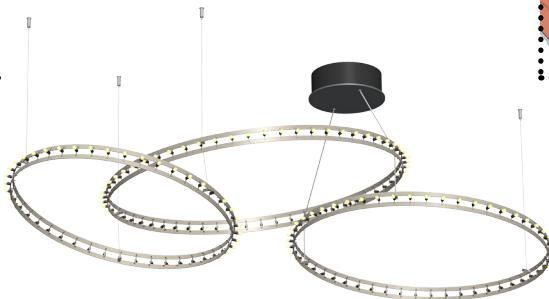
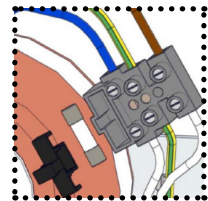
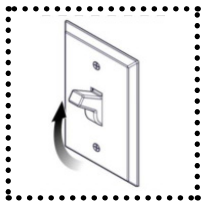

Zie zekering voor type
See fuse for type
siehe zum Sicherungstyp

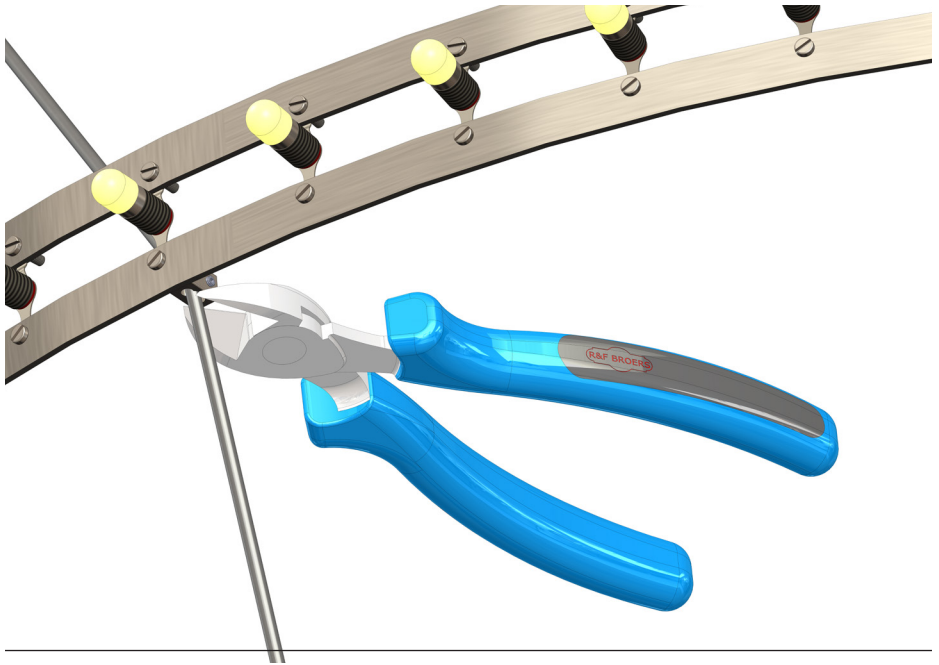

Lined writing area with 25 horizontal lines.



Quasar Holland B.V.
Burgstraat 2
4283 GG Giessen
The Netherlands

T: 31-183-447887
E. info@quasar.nl
I. www.quasar.nl

Date: 15-11-2019
Version: 2